

NCP1117, NCV1117

1.0 A Low-Dropout Positive Fixed and Adjustable Voltage Regulators

The NCP1117 series are low dropout positive voltage regulators that are capable of providing an output current that is in excess of 1.0 A with a maximum dropout voltage of 1.2 V at 800 mA over temperature. This series contains eight fixed output voltages of 1.5 V, 1.8 V, 2.0 V, 2.5 V, 2.85 V, 3.3 V, 5.0 V, and 12 V that have no minimum load requirement to maintain regulation. Also included is an adjustable output version that can be programmed from 1.25 V to 18.8 V with two external resistors. On chip trimming adjusts the reference/output voltage to within $\pm 1.0\%$ accuracy. Internal protection features consist of output current limiting, safe operating area compensation, and thermal shutdown. The NCP1117 series can operate with up to 20 V input. Devices are available in SOT-223 and DPAK packages.

Features

- Output Current in Excess of 1.0 A
- 1.2 V Maximum Dropout Voltage at 800 mA Over Temperature
- Fixed Output Voltages of 1.5 V, 1.8 V, 2.0 V, 2.5 V, 2.85 V, 3.3 V, 5.0 V, and 12 V
- Adjustable Output Voltage Option
- No Minimum Load Requirement for Fixed Voltage Output Devices
- Reference/Output Voltage Trimmed to $\pm 1.0\%$
- Current Limit, Safe Operating and Thermal Shutdown Protection
- Operation to 20 V Input
- NCV Prefix for Automotive and Other Applications Requiring Site and Control Changes
- Pb-Free Packages are Available

Applications

- Consumer and Industrial Equipment Point of Regulation
- Active SCSI Termination for 2.85 V Version
- Switching Power Supply Post Regulation
- Hard Drive Controllers
- Battery Chargers



ON Semiconductor®

<http://onsemi.com>

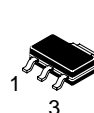

SOT-223
ST SUFFIX
CASE 318H

(Top View)

Pin: 1. Adjust/Ground
2. Output
3. Input

Heatsink tab is connected to Pin 2.

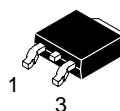

DPAK
DT SUFFIX
CASE 369C

(Top View)

ORDERING INFORMATION

See detailed ordering and shipping information in the package dimensions section on pages 11 and 12 of this data sheet.

DEVICE MARKING INFORMATION

See general marking information in the device marking section on page 13 of this data sheet.

TYPICAL APPLICATIONS

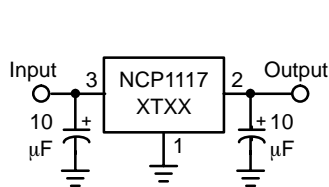

Figure 1. Fixed Output Regulator

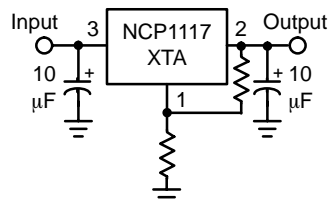

Figure 2. Adjustable Output Regulator

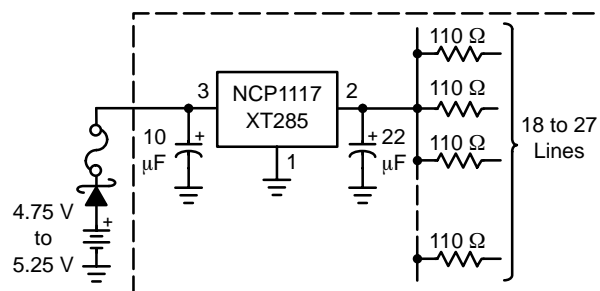

Figure 3. Active SCSI Bus Terminator

NCP1117, NCV1117

MAXIMUM RATINGS

Rating	Symbol	Value	Unit
Input Voltage (Note 1)	V_{in}	20	V
Output Short Circuit Duration (Notes 2 and 3)	–	Infinite	–
Power Dissipation and Thermal Characteristics			
Case 318H (SOT–223)			
Power Dissipation (Note 2)	P_D	Internally Limited	W
Thermal Resistance, Junction–to–Ambient, Minimum Size Pad	$R_{\theta JA}$	160	°C/W
Thermal Resistance, Junction–to–Case	$R_{\theta JC}$	15	°C/W
Case 369A (DPAK)			
Power Dissipation (Note 2)	P_D	Internally Limited	W
Thermal Resistance, Junction–to–Ambient, Minimum Size Pad	$R_{\theta JA}$	67	°C/W
Thermal Resistance, Junction–to–Case	$R_{\theta JC}$	6.0	°C/W
Maximum Die Junction Temperature Range	T_J	–55 to 150	°C
Storage Temperature Range	T_{stg}	–65 to 150	°C
Operating Ambient Temperature Range	T_A	0 to +125	°C
NCP1117		–40 to +125	
NCV1117			

Maximum ratings are those values beyond which device damage can occur. Maximum ratings applied to the device are individual stress limit values (not normal operating conditions) and are not valid simultaneously. If these limits are exceeded, device functional operation is not implied, damage may occur and reliability may be affected.

- This device series contains ESD protection and exceeds the following tests:
Human Body Model 2000 V per MIL–STD–883, Method 3015.
Machine Model Method 200 V.
- Internal thermal shutdown protection limits the die temperature to approximately 175°C. Proper heatsinking is required to prevent activation. The maximum package power dissipation is:

$$P_D = \frac{T_{J(max)} - T_A}{R_{\theta JA}}$$
- The regulator output current must not exceed 1.0 A with V_{in} greater than 12 V.

NCP1117, NCV1117

ELECTRICAL CHARACTERISTICS ($C_{in} = 10 \mu\text{F}$, $C_{out} = 10 \mu\text{F}$, for typical value $T_A = 25^\circ\text{C}$, for min and max values T_A is the operating ambient temperature range that applies unless otherwise noted. (Note 6)

Characteristic	Symbol	Min	Typ	Max	Unit
Reference Voltage, Adjustable Output Devices ($V_{in}-V_{out} = 2.0 \text{ V}$, $I_{out} = 10 \text{ mA}$, $T_A = 25^\circ\text{C}$) ($V_{in}-V_{out} = 1.4 \text{ V to } 10 \text{ V}$, $I_{out} = 10 \text{ mA to } 800 \text{ mA}$) (Note 6)	V_{ref}	1.238 1.225	1.25 –	1.262 1.270	V
Output Voltage, Fixed Output Devices	V_{out}				V
1.5 V ($V_{in} = 3.5 \text{ V}$, $I_{out} = 10 \text{ mA}$, $T_A = 25^\circ\text{C}$) ($V_{in} = 2.9 \text{ V to } 11.5 \text{ V}$, $I_{out} = 0 \text{ mA to } 800 \text{ mA}$) (Note 6)		1.485 1.470	1.500 –	1.515 1.530	
1.8 V ($V_{in} = 3.8 \text{ V}$, $I_{out} = 10 \text{ mA}$, $T_A = 25^\circ\text{C}$) ($V_{in} = 3.2 \text{ V to } 11.8 \text{ V}$, $I_{out} = 0 \text{ mA to } 800 \text{ mA}$) (Note 6)		1.782 1.755	1.800 –	1.818 1.845	
2.0 V ($V_{in} = 4.0 \text{ V}$, $I_{out} = 10 \text{ mA}$, $T_A = 25^\circ\text{C}$) ($V_{in} = 3.4 \text{ V to } 12 \text{ V}$, $I_{out} = 0 \text{ mA to } 800 \text{ mA}$) (Note 6)		1.970 1.960	2.000 –	2.030 2.040	
2.5 V ($V_{in} = 4.5 \text{ V}$, $I_{out} = 10 \text{ mA}$, $T_A = 25^\circ\text{C}$) ($V_{in} = 3.9 \text{ V to } 10 \text{ V}$, $I_{out} = 0 \text{ mA to } 800 \text{ mA}$,) (Note 6)		2.475 2.450	2.500 –	2.525 2.550	
2.85 V ($V_{in} = 4.85 \text{ V}$, $I_{out} = 10 \text{ mA}$, $T_A = 25^\circ\text{C}$) ($V_{in} = 4.25 \text{ V to } 10 \text{ V}$, $I_{out} = 0 \text{ mA to } 800 \text{ mA}$) (Note 6) ($V_{in} = 4.0 \text{ V}$, $I_{out} = 0 \text{ mA to } 500 \text{ mA}$) (Note 6)		2.821 2.790 2.790	2.850 – –	2.879 2.910 2.910	
3.3 V ($V_{in} = 5.3 \text{ V}$, $I_{out} = 10 \text{ mA}$, $T_A = 25^\circ\text{C}$) ($V_{in} = 4.75 \text{ V to } 10 \text{ V}$, $I_{out} = 0 \text{ mA to } 800 \text{ mA}$) (Note 6)		3.267 3.235	3.300 –	3.333 3.365	
5.0 V ($V_{in} = 7.0 \text{ V}$, $I_{out} = 10 \text{ mA}$, $T_A = 25^\circ\text{C}$) ($V_{in} = 6.5 \text{ V to } 12 \text{ V}$, $I_{out} = 0 \text{ mA to } 800 \text{ mA}$) (Note 6)		4.950 4.900	5.000 –	5.050 5.100	
12 V ($V_{in} = 14 \text{ V}$, $I_{out} = 10 \text{ mA}$, $T_A = 25^\circ\text{C}$) ($V_{in} = 13.5 \text{ V to } 20 \text{ V}$, $I_{out} = 0 \text{ mA to } 800 \text{ mA}$) (Note 6)		11.880 11.760	12.000 –	12.120 12.240	
Line Regulation (Note 4) Adjustable ($V_{in} = 2.75 \text{ V to } 16.25 \text{ V}$, $I_{out} = 10 \text{ mA}$)	Reg_{line}	–	0.04	0.1	%
1.5 V ($V_{in} = 2.9 \text{ V to } 11.5 \text{ V}$, $I_{out} = 0 \text{ mA}$)		–	0.3	1.0	mV
1.8 V ($V_{in} = 3.2 \text{ V to } 11.8 \text{ V}$, $I_{out} = 0 \text{ mA}$)		–	0.4	1.0	
2.0 V ($V_{in} = 3.4 \text{ V to } 12 \text{ V}$, $I_{out} = 0 \text{ mA}$)		–	0.5	2.5	
2.5 V ($V_{in} = 3.9 \text{ V to } 10 \text{ V}$, $I_{out} = 0 \text{ mA}$)		–	0.5	2.5	
2.85 V ($V_{in} = 4.25 \text{ V to } 10 \text{ V}$, $I_{out} = 0 \text{ mA}$)		–	0.8	3.0	
3.3 V ($V_{in} = 4.75 \text{ V to } 15 \text{ V}$, $I_{out} = 0 \text{ mA}$)		–	0.8	4.5	
5.0 V ($V_{in} = 6.5 \text{ V to } 15 \text{ V}$, $I_{out} = 0 \text{ mA}$)		–	0.9	6.0	
12 V ($V_{in} = 13.5 \text{ V to } 20 \text{ V}$, $I_{out} = 0 \text{ mA}$)		–	1.0	7.5	
Load Regulation (Note 4) Adjustable ($I_{out} = 10 \text{ mA to } 800 \text{ mA}$, $V_{in} = 4.25 \text{ V}$)	Reg_{line}	–	0.2	0.4	
1.5 V ($I_{out} = 0 \text{ mA to } 800 \text{ mA}$, $V_{in} = 2.9 \text{ V}$)		–	2.3	5.5	mV
1.8 V ($I_{out} = 0 \text{ mA to } 800 \text{ mA}$, $V_{in} = 3.2 \text{ V}$)		–	2.6	6.0	
2.0 V ($I_{out} = 0 \text{ mA to } 800 \text{ mA}$, $V_{in} = 3.4 \text{ V}$)		–	3.0	6.0	
2.5 V ($I_{out} = 0 \text{ mA to } 800 \text{ mA}$, $V_{in} = 3.9 \text{ V}$)		–	3.3	7.5	
2.85 V ($I_{out} = 0 \text{ mA to } 800 \text{ mA}$, $V_{in} = 4.25 \text{ V}$)		–	3.8	8.0	
3.3 V ($I_{out} = 0 \text{ mA to } 800 \text{ mA}$, $V_{in} = 4.75 \text{ V}$)		–	4.3	10	
5.0 V ($I_{out} = 0 \text{ mA to } 800 \text{ mA}$, $V_{in} = 6.5 \text{ V}$)		–	6.7	15	
12 V ($I_{out} = 0 \text{ mA to } 800 \text{ mA}$, $V_{in} = 13.5 \text{ V}$)		–	16	28	
Dropout Voltage (Measured at $V_{out} - 100 \text{ mV}$) ($I_{out} = 100 \text{ mA}$) ($I_{out} = 500 \text{ mA}$) ($I_{out} = 800 \text{ mA}$)	$V_{in}-V_{out}$	– – –	0.95 1.01 1.07	1.10 1.15 1.20	
Output Current Limit ($V_{in}-V_{out} = 5.0 \text{ V}$, $T_A = 25^\circ\text{C}$, Note 5)	I_{out}	1000	1500	2200	mA

4. Low duty cycle pulse techniques are used during testing to maintain the junction temperature as close to ambient as possible.
5. The regulator output current must not exceed 1.0 A with V_{in} greater than 12 V.
6. NCP1117: $T_{low} = 0^\circ\text{C}$, $T_{high} = 125^\circ\text{C}$
NCV1117: $T_{low} = -40^\circ\text{C}$, $T_{high} = 125^\circ\text{C}$

NCP1117, NCV1117

ELECTRICAL CHARACTERISTICS ($C_{in} = 10 \mu\text{F}$, $C_{out} = 10 \mu\text{F}$, for typical value $T_A = 25^\circ\text{C}$, for min and max values T_A is the operating ambient temperature range that applies unless otherwise noted. (Note 7)

Characteristic	Symbol	Min	Typ	Max	Unit
Minimum Required Load Current for Regulation, Adjustable Output Devices ($V_{in} = 15 \text{ V}$)	$I_{L(\text{min})}$	–	0.8	5.0	mA
Quiescent Current 1.5 V ($V_{in} = 11.5 \text{ V}$) 1.8 V ($V_{in} = 11.8 \text{ V}$) 2.0 V ($V_{in} = 12 \text{ V}$) 2.5 V ($V_{in} = 10 \text{ V}$) 2.85 V ($V_{in} = 10 \text{ V}$) 3.3 V ($V_{in} = 15 \text{ V}$) 5.0 V ($V_{in} = 15 \text{ V}$) 12 V ($V_{in} = 20 \text{ V}$)	I_Q	–	3.6 4.2 4.5 5.2 5.5 6.0 6.0 6.0	10 10 10 10 10 10 10 10	mA
Thermal Regulation ($T_A = 25^\circ\text{C}$, 30 ms Pulse)		–	0.01	0.1	%/W
Ripple Rejection ($V_{in}-V_{out} = 6.4 \text{ V}$, $I_{out} = 500 \text{ mA}$, 10 V _{pp} 120 Hz Sinewave) Adjustable 1.5 V 1.8 V 2.0 V 2.5 V 2.85 V 3.3 V 5.0 V 12 V	RR	67 66 64 64 62 62 60 57 50	73 72 70 70 68 68 64 61 54	– – – – – – – – –	dB
Adjustment Pin Current ($V_{in} = 11.25 \text{ V}$, $I_{out} = 800 \text{ mA}$)	I_{adj}	–	52	120	μA
Adjust Pin Current Change ($V_{in}-V_{out} = 1.4 \text{ V}$ to 10 V, $I_{out} = 10 \text{ mA}$ to 800 mA)	ΔI_{adj}	–	0.4	5.0	μA
Temperature Stability	S_T	–	0.5	–	%
Long Term Stability ($T_A = 25^\circ\text{C}$, 1000 Hrs End Point Measurement)	S_t	–	0.3	–	%
RMS Output Noise ($f = 10 \text{ Hz}$ to 10 kHz)	N	–	0.003	–	% V_{out}

7. NCP1117: $T_{low} = 0^\circ\text{C}$, $T_{high} = 125^\circ\text{C}$
 NCV1117: $T_{low} = -40^\circ\text{C}$, $T_{high} = 125^\circ\text{C}$

NCP1117, NCV1117

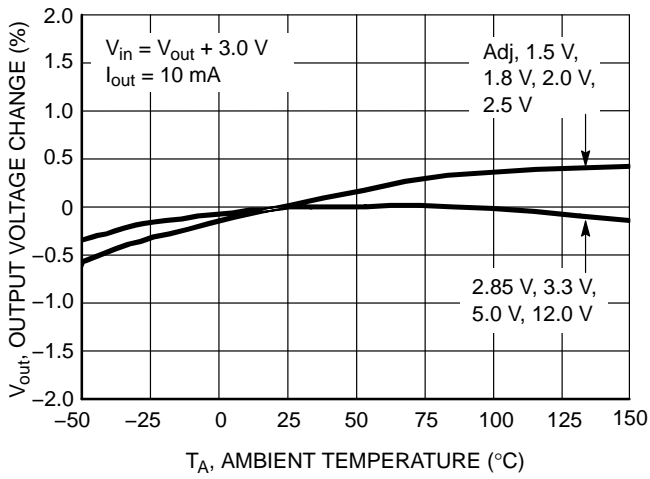

Figure 4. Output Voltage Change vs. Temperature

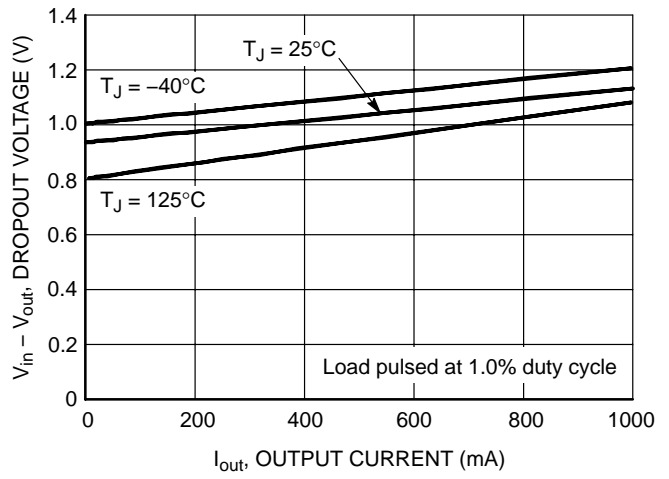

Figure 5. Dropout Voltage vs. Output Current

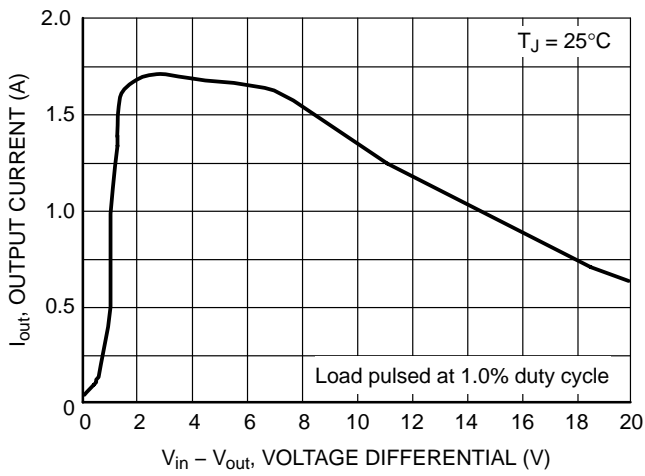

Figure 6. Output Short Circuit Current vs. Differential Voltage

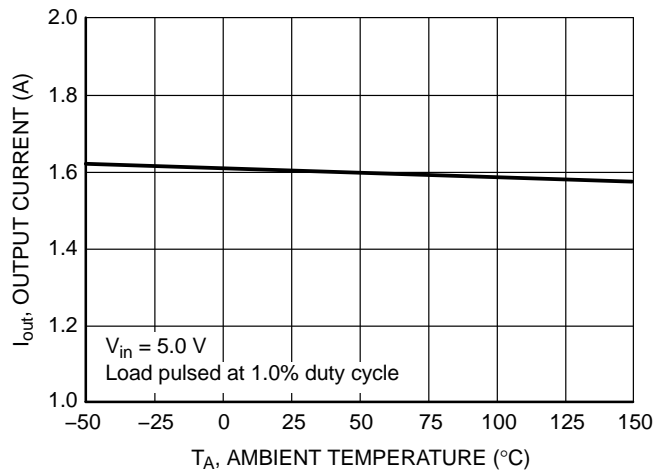

Figure 7. Output Short Circuit Current vs. Temperature

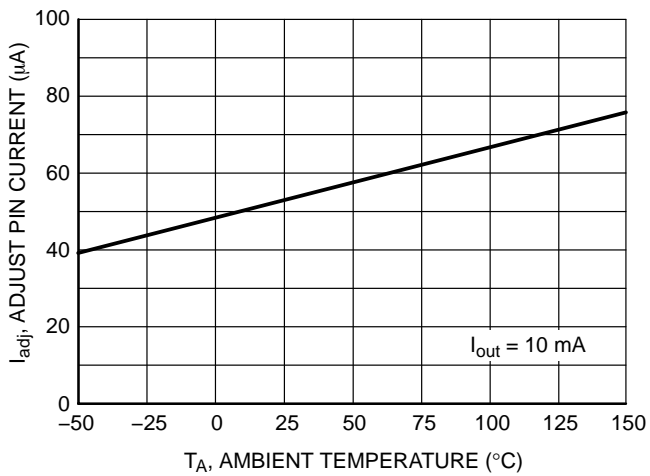

Figure 8. Adjust Pin Current vs. Temperature

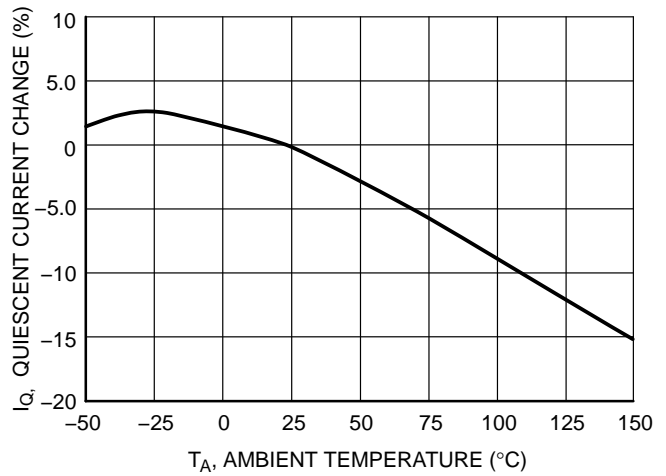

Figure 9. Quiescent Current Change vs. Temperature

NCP1117, NCV1117

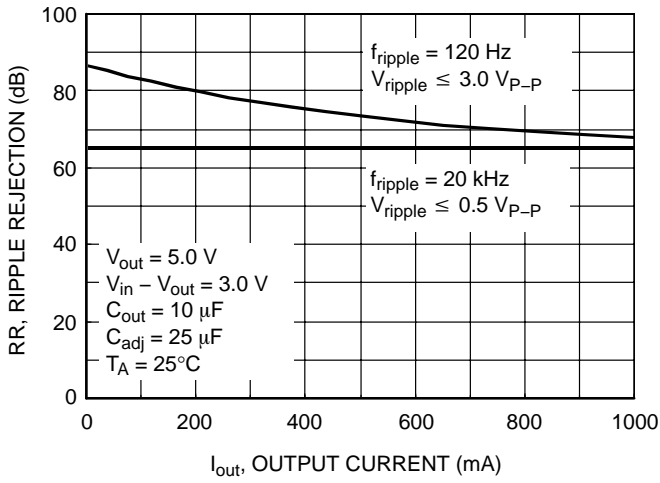

Figure 10. NCP1117XTA Ripple Rejection vs. Output Current

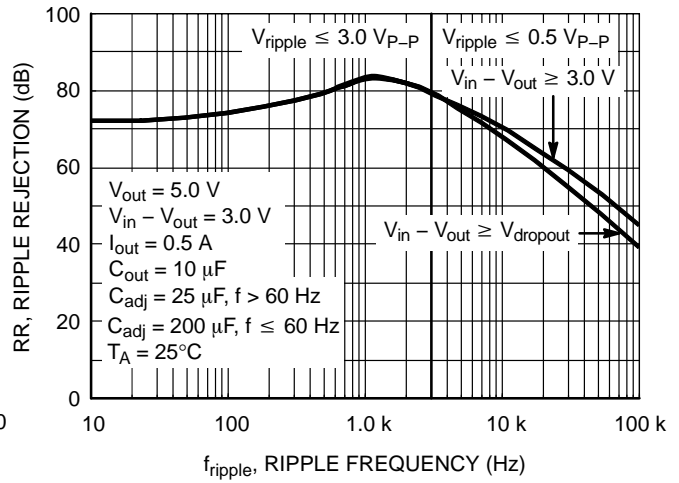

Figure 11. NCP1117XTA Ripple Rejection vs. Frequency

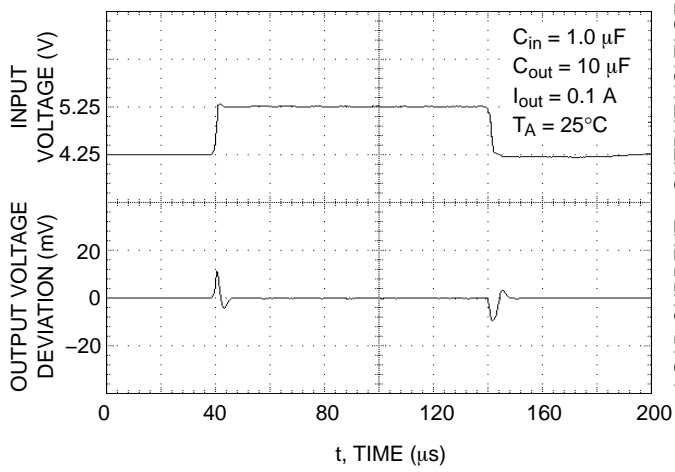

Figure 12. NCP1117XT285 Line Transient Response

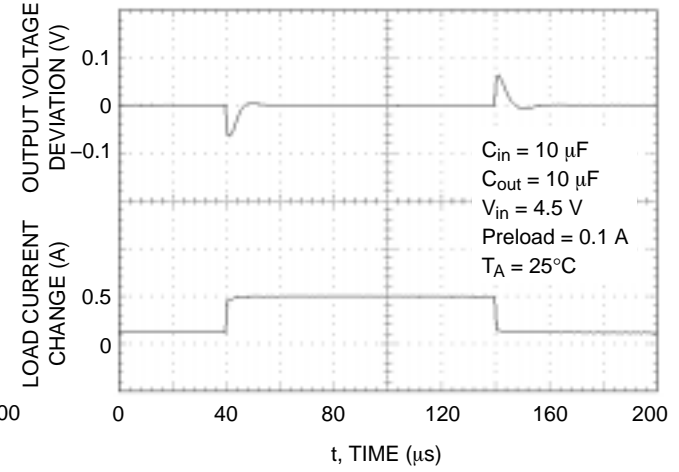

Figure 13. NCP1117XT285 Load Transient Response

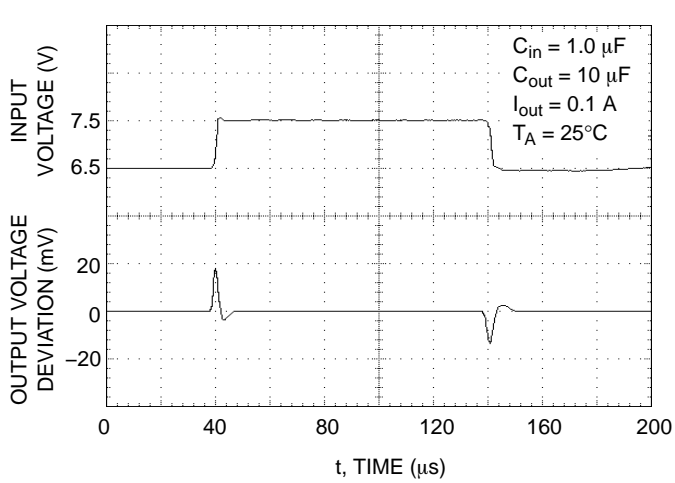

Figure 14. NCP1117XT50 Line Transient Response

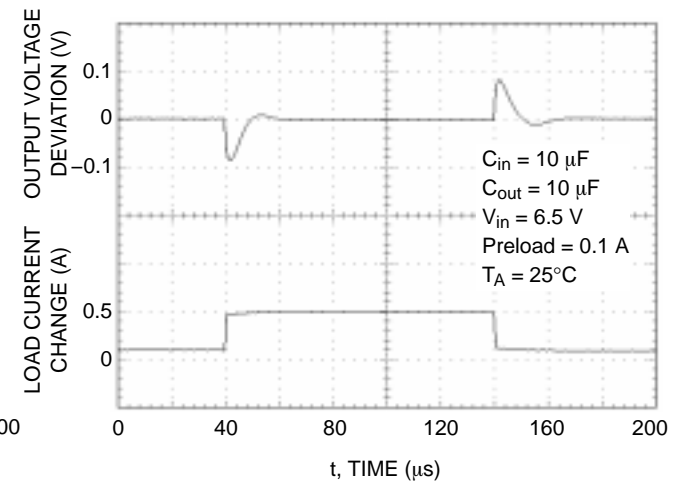

Figure 15. NCP1117XT50 Load Transient Response

NCP1117, NCV1117

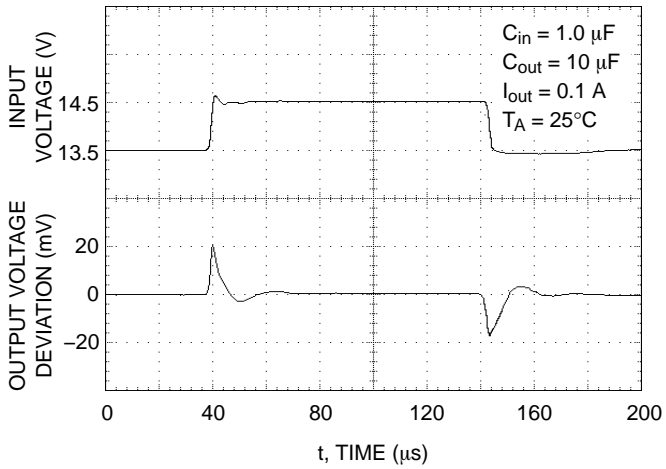

Figure 16. NCP1117XT12 Line Transient Response

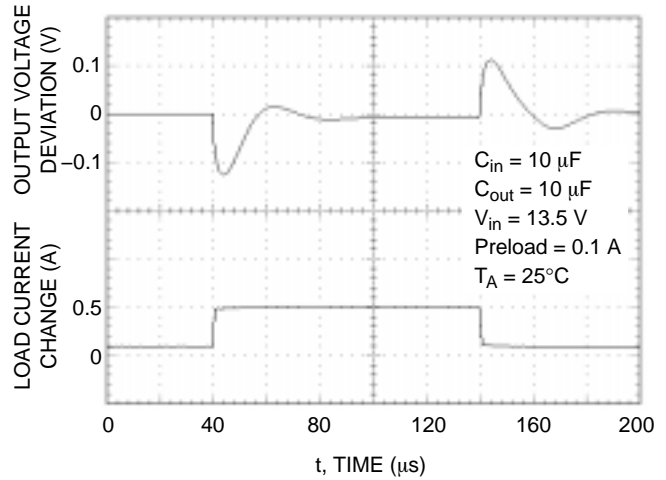

Figure 17. NCP1117XT12 Load Transient Response

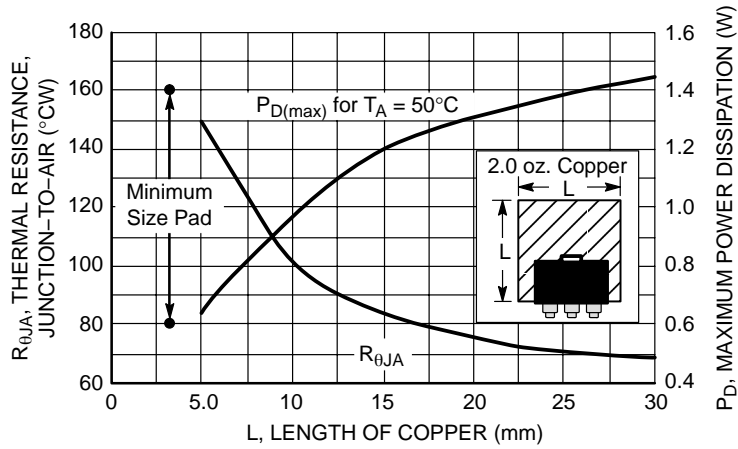

Figure 18. SOT-223 Thermal Resistance and Maximum Power Dissipation vs. P.C.B. Copper Length

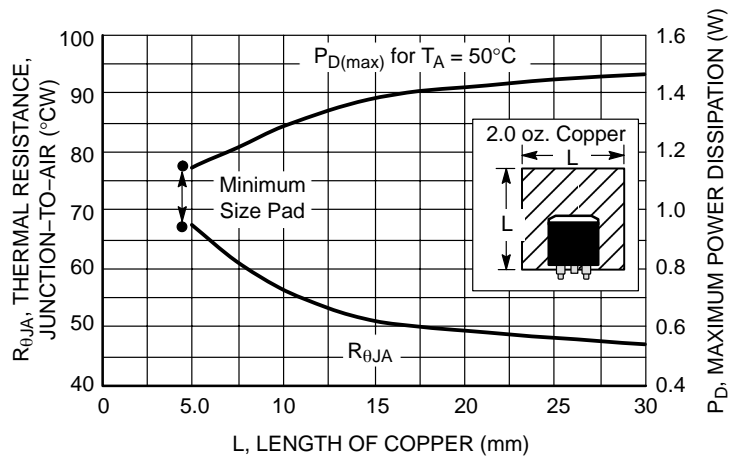

Figure 19. DPAK Thermal Resistance and Maximum Power Dissipation vs. P.C.B. Copper Length

APPLICATIONS INFORMATION

Introduction

The NCP1117 features a significant reduction in dropout voltage along with enhanced output voltage accuracy and temperature stability when compared to older industry standard three-terminal adjustable regulators. These devices contain output current limiting, safe operating area compensation and thermal shutdown protection making them designer friendly for powering numerous consumer and industrial products. The NCP1117 series is pin compatible with the older LM317 and its derivative device types.

Output Voltage

The typical application circuits for the fixed and adjustable output regulators are shown in Figures 20 and 21. The adjustable devices are floating voltage regulators. They develop and maintain the nominal 1.25 V reference voltage between the output and adjust pins. The reference voltage is programmed to a constant current source by resistor R1, and this current flows through R2 to ground to set the output voltage. The programmed current level is usually selected to be greater than the specified 5.0 mA minimum that is required for regulation. Since the adjust pin current, I_{adj} , is significantly lower and constant with respect to the programmed load current, it generates a small output voltage error that can usually be ignored. For the fixed output devices R1 and R2 are included within the device and the ground current I_{gnd} , ranges from 3.0 mA to 5.0 mA depending upon the output voltage.

External Capacitors

Input bypass capacitor C_{in} may be required for regulator stability if the device is located more than a few inches from the power source. This capacitor will reduce the circuit's sensitivity when powered from a complex source impedance and significantly enhance the output transient response. The input bypass capacitor should be mounted with the shortest possible track length directly across the regulator's input and ground terminals. A 10 μ F ceramic or tantalum capacitor should be adequate for most applications.

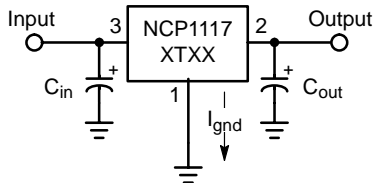
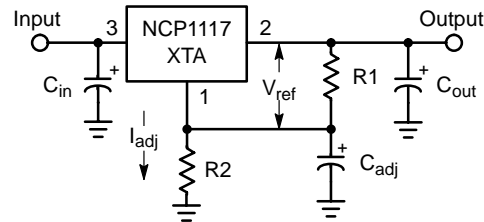

Figure 20. Fixed Output Regulator

Frequency compensation for the regulator is provided by capacitor C_{out} and its use is mandatory to ensure output stability. A minimum capacitance value of 4.7 μ F with an equivalent series resistance (ESR) that is within the limits of 0.25 Ω to 2.2 Ω is required. The capacitor type can be ceramic, tantalum, or aluminum electrolytic as long as it meets the minimum capacitance value and ESR limits over the circuit's entire operating temperature range. Higher values of output capacitance can be used to enhance loop stability and transient response with the additional benefit of reducing output noise.



$$V_{out} = V_{ref} \left(1 + \frac{R2}{R1} \right) + I_{adj} R2$$

Figure 21. Adjustable Output Regulator

The output ripple will increase linearly for fixed and adjustable devices as the ratio of output voltage to the reference voltage increases. For example, with a 12 V regulator, the output ripple will increase by 12 V/1.25 V or 9.6 and the ripple rejection will decrease by 20 log of this ratio or 19.6 dB. The loss of ripple rejection can be restored to the values shown with the addition of bypass capacitor C_{adj} , shown in Figure 21. The reactance of C_{adj} at the ripple frequency must be less than the resistance of R1. The value of R1 can be selected to provide the minimum required load current to maintain regulation and is usually in the range of 100 Ω to 200 Ω .

$$C_{adj} > \frac{1}{2 \pi f_{ripple} R1}$$

The minimum required capacitance can be calculated from the above formula. When using the device in an application that is powered from the AC line via a transformer and a full wave bridge, the value for C_{adj} is:

$$f_{ripple} = 120 \text{ Hz}, R1 = 120 \Omega, \text{ then } C_{adj} > 11.1 \mu\text{F}$$

The value for C_{adj} is significantly reduced in applications where the input ripple frequency is high. If used as a post regulator in a switching converter under the following conditions:

$$f_{ripple} = 50 \text{ kHz}, R1 = 120 \Omega, \text{ then } C_{adj} > 0.027 \mu\text{F}$$

Figures 10 and 11 shows the level of ripple rejection that is obtainable with the adjust pin properly bypassed.

Protection Diodes

The NCP1117 family has two internal low impedance diode paths that normally do not require protection when used in the typical regulator applications. The first path connects between V_{out} and V_{in} , and it can withstand a peak surge current of about 15 A. Normal cycling of V_{in} cannot generate a current surge of this magnitude. Only when V_{in} is shorted or crowbarred to ground and C_{out} is greater than 50 μ F, it becomes possible for device damage to occur. Under these conditions, diode D1 is required to protect the device. The second path connects between C_{adj} and V_{out} , and it can withstand a peak surge current of about 150 mA. Protection diode D2 is required if the output is shorted or crowbarred to ground and C_{adj} is greater than 1.0 μ F.

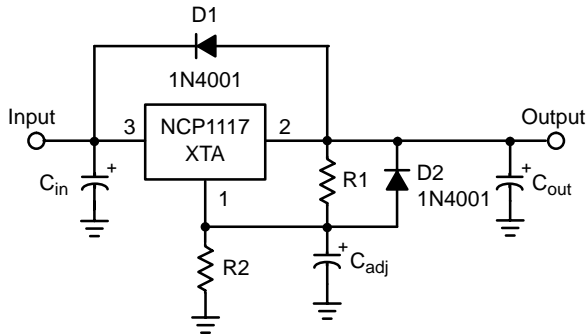

Figure 22. Protection Diode Placement

A combination of protection diodes D1 and D2 may be required in the event that V_{in} is shorted to ground and C_{adj} is greater than 50 μ F. The peak current capability stated for the internal diodes are for a time of 100 μ s with a junction temperature of 25°C. These values may vary and are to be used as a general guide.

Load Regulation

The NCP1117 series is capable of providing excellent load regulation; but since these are three terminal devices, only partial remote load sensing is possible. There are two conditions that must be met to achieve the maximum available load regulation performance. The first is that the top side of programming resistor R1 should be connected as close to the regulator case as practicable. This will minimize the voltage drop caused by wiring resistance $RW+$ from appearing in series with reference voltage that is across R1.

The second condition is that the ground end of R2 should be connected directly to the load. This allows true Kelvin sensing where the regulator compensates for the voltage drop caused by wiring resistance $RW-$.

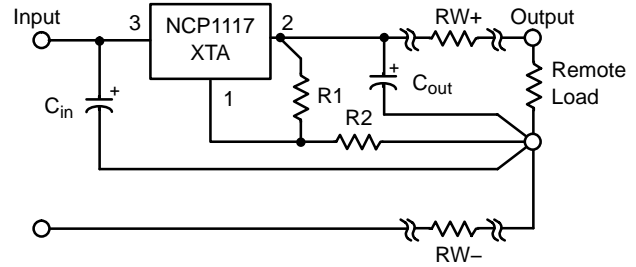

Figure 23. Load Sensing

Thermal Considerations

This series contains an internal thermal limiting circuit that is designed to protect the regulator in the event that the maximum junction temperature is exceeded. When activated, typically at 175°C, the regulator output switches off and then back on as the die cools. As a result, if the device is continuously operated in an overheated condition, the output will appear to be oscillating. This feature provides protection from a catastrophic device failure due to accidental overheating. It is not intended to be used as a substitute for proper heatsinking. The maximum device power dissipation can be calculated by:

$$PD = \frac{T_{J(max)} - T_A}{R_{\theta JA}}$$

The devices are available in surface mount SOT-223 and DPAK packages. Each package has an exposed metal tab that is specifically designed to reduce the junction to air thermal resistance, $R_{\theta JA}$, by utilizing the printed circuit board copper as a heat dissipater. Figures 18 and 19 show typical $R_{\theta JA}$ values that can be obtained from a square pattern using economical single sided 2.0 ounce copper board material. The final product thermal limits should be tested and quantified in order to insure acceptable performance and reliability. The actual $R_{\theta JA}$ can vary considerably from the graphs shown. This will be due to any changes made in the copper aspect ratio of the final layout, adjacent heat sources, and air flow.

NCP1117, NCV1117

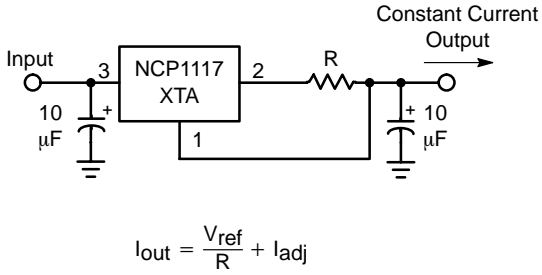

Figure 24. Constant Current Regulator

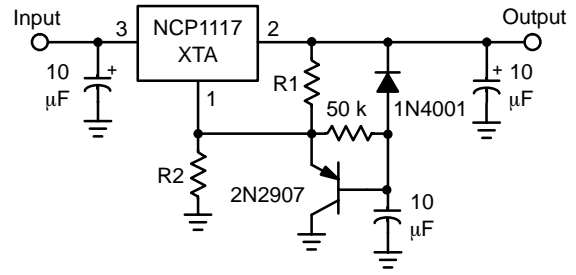

Figure 25. Slow Turn-On Regulator

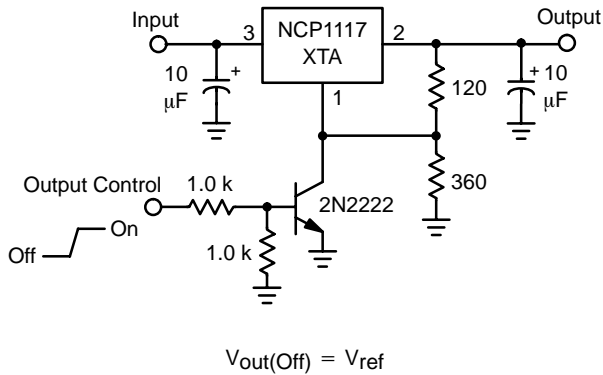
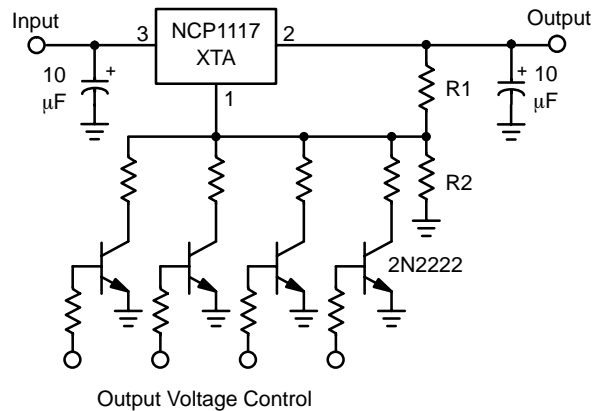
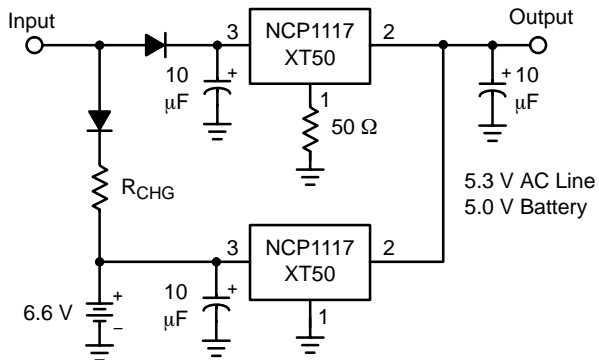

Figure 26. Regulator with Shutdown



Resistor R2 sets the maximum output voltage. Each transistor reduces the output voltage when turned on.

Figure 27. Digitally Controlled Regulator



The 50 Ω resistor that is in series with the ground pin of the upper regulator level shifts its output 300 mV higher than the lower regulator. This keeps the lower regulator off until the input source is removed.

Figure 28. Battery Backed-Up Power Supply

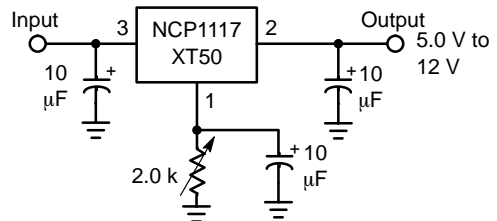

Figure 29. Adjusting Output of Fixed Voltage Regulators

NCP1117, NCV1117

ORDERING INFORMATION

Device	Nominal Output Voltage	Package	Shipping†
NCP1117DTA	Adjustable	DPAK	75 Units / Rail
NCP1117DTAG	Adjustable	DPAK (Pb-Free)	75 Units / Rail
NCP1117DTARK	Adjustable	DPAK	2500 / Tape & Reel
NCP1117DTARKG	Adjustable	DPAK (Pb-Free)	2500 / Tape & Reel
NCP1117DTAT5	Adjustable	DPAK	2500 / Tape & Reel
NCP1117STAT3	Adjustable	SOT-223	4000 / Tape & Reel
NCP1117STAT3G	Adjustable	SOT-223 (Pb-Free)	4000 / Tape & Reel
NCP1117DT12	12	DPAK	75 Units / Rail
NCP1117DT12RK	12	DPAK	2500 / Tape & Reel
NCP1117DT12T3	12	SOT-223	4000 / Tape & Reel
NCP1117DT15	1.5	DPAK	75 Units / Rail
NCP1117DT15RK	1.5	DPAK	2500 / Tape & Reel
NCP1117DT15RKG	1.5	DPAK (Pb-Free)	2500 / Tape & Reel
NCP1117ST15T3	1.5	SOT-223	4000 / Tape & Reel
NCP1117ST15T3G	1.5	SOT-223 (Pb-Free)	4000 / Tape & Reel
NCP1117DT18	1.8	DPAK	75 Units / Rail
NCP1117DT18RK	1.8	DPAK	2500 / Tape & Reel
NCP1117DT18RKG	1.8	DPAK (Pb-Free)	2500 / Tape & Reel
NCP1117DT18T5	1.8	DPAK	2500 / Tape & Reel
NCP1117DT18T5G	1.8	DPAK (Pb-Free)	2500 / Tape & Reel
NCP1117ST18T3	1.8	SOT-223	4000 / Tape & Reel
NCP1117ST18T3G	1.8	SOT-223 (Pb-Free)	4000 / Tape & Reel
NCP1117DT20	2.0	DPAK	75 Units / Rail
NCP1117DT20RK	2.0	DPAK	2500 / Tape & Reel
NCP1117ST20T3	2.0	SOT-223	4000 / Tape & Reel
NCP1117ST20T3G	2.0	SOT-223 (Pb-Free)	4000 / Tape & Reel
NCP1117DT25	2.5	DPAK	75 Units / Rail
NCP1117DT25RK	2.5	DPAK	2500 / Tape & Reel
NCP1117DT25RKG	2.5	DPAK (Pb-Free)	2500 / Tape & Reel
NCP1117DT25T5	2.5	DPAK	2500 / Tape & Reel
NCP1117ST25T3	2.5	SOT-223	4000 / Tape & Reel
NCP1117ST25T3G	2.5	SOT-223 (Pb-Free)	4000 / Tape & Reel

†For information on tape and reel specifications, including part orientation and tape sizes, please refer to our Tape and Reel Packaging Specifications Brochure, BRD8011/D.

*NCV prefix is for automotive and other applications requiring site and control changes.

NCP1117, NCV1117

ORDERING INFORMATION

Device	Nominal Output Voltage	Package	Shipping†
NCP1117DT285	2.85	DPAK	75 Units / Rail
NCP1117DT285RK	2.85	DPAK	2500 / Tape & Reel
NCP1117ST285T3	2.85	SOT-223	4000 / Tape & Reel
NCP1117DT33	3.3	DPAK	75 Units / Rail
NCP1117DT33RK	3.3	DPAK	2500 / Tape & Reel
NCP1117DT33RKG	3.3	DPAK (Pb-Free)	2500 / Tape & Reel
NCP1117DT33T5	3.3	DPAK	2500 / Tape & Reel
NCP1117DT33T5G	3.3	DPAK (Pb-Free)	2500 / Tape & Reel
NCP1117ST33T3	3.3	SOT-223	4000 / Tape & Reel
NCP1117ST33T3G	3.3	SOT-223 (Pb-Free)	4000 / Tape & Reel
NCP1117DT50	5.0	DPAK	75 Units/Rail
NCP1117DT50RK	5.0	DPAK	2500 / Tape & Reel
NCP1117DT50RKG	5.0	DPAK (Pb-Free)	2500 / Tape & Reel
NCP1117ST50T3	5.0	SOT-223	4000 / Tape & Reel
NCV1117DTARK*	Adjustable	DPAK	2500 / Tape & Reel
NCV1117STAT3*	Adjustable	SOT-223	4000 / Tape & Reel
NCV1117STAT3G*	Adjustable	SOT-223 (Pb-Free)	4000 / Tape & Reel
NCV1117ST12T3*	12	SOT-223	4000 / Tape & Reel
NCV1117ST12T3G*	12	SOT-223 (Pb-Free)	4000 / Tape & Reel
NCV1117DT15RK*	1.5	DPAK	2500 / Tape & Reel
NCV1117DT15RKG*	1.5	DPAK (Pb-Free)	2500 / Tape & Reel
NCV1117ST15T3*	1.5	SOT-223	4000 / Tape & Reel
NCV1117DT18T5*	1.8	DPAK	2500 / Tape & Reel
NCV1117DT25RK*	2.5	DPAK	2500 / Tape & Reel
NCV1117ST25T3*	2.5	SOT-223	4000 / Tape & Reel
NCV1117DT33T5*	3.3	DPAK	2500 / Tape & Reel
NCV1117DT50RK*	5.0	DPAK	2500 / Tape & Reel

†For information on tape and reel specifications, including part orientation and tape sizes, please refer to our Tape and Reel Packaging Specifications Brochure, BRD8011/D.

*NCV prefix is for automotive and other applications requiring site and control changes.

NCP1117, NCV1117

MARKING DIAGRAMS

SOT-223 ST SUFFIX CASE 318H

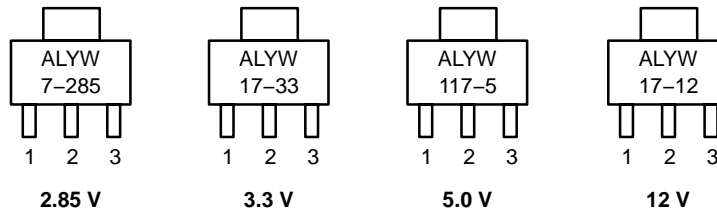
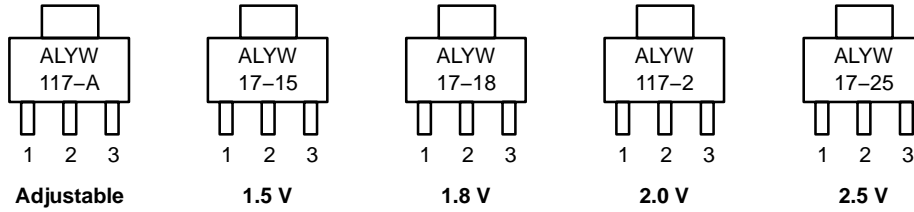

DPAK DT SUFFIX CASE 369C

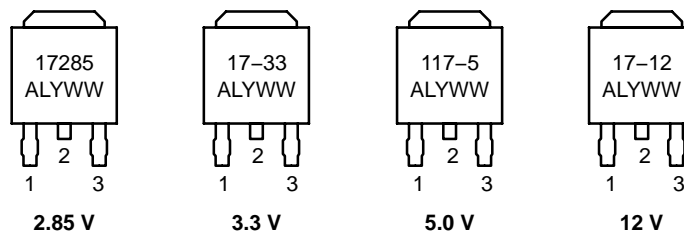
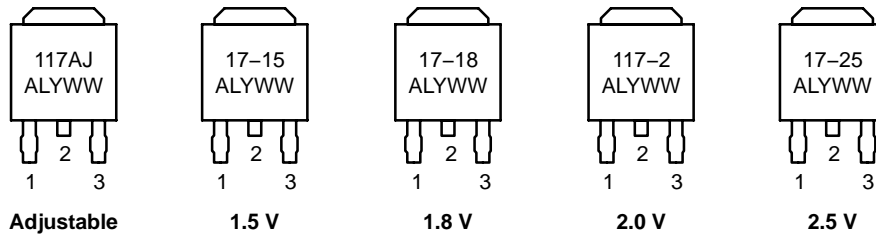

A = Assembly Location
L = Wafer Lot
Y = Year
WW, W = Work Week

NCP1117, NCV1117

PACKAGE DIMENSIONS

SOT-223
ST SUFFIX
CASE 318H-01
ISSUE O

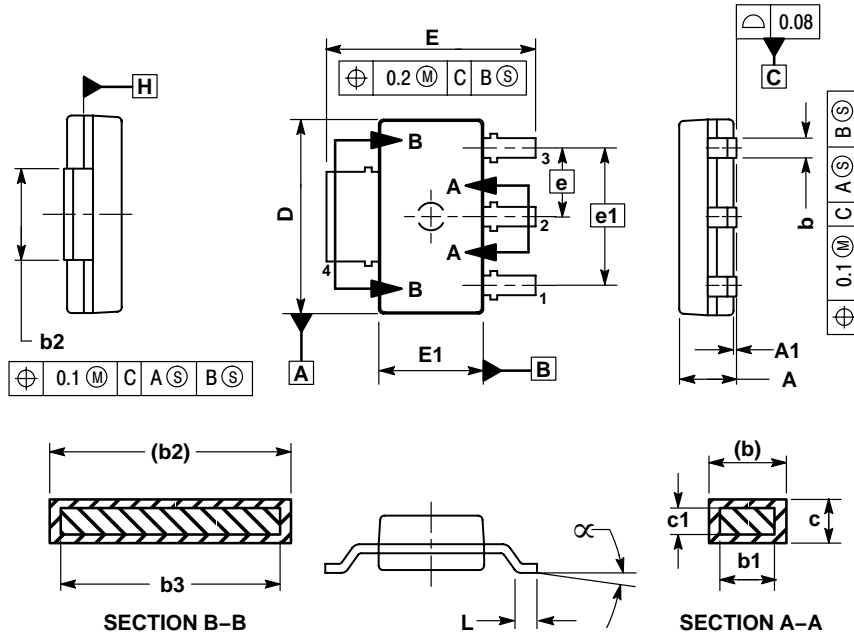

NOTES:

1. DIMENSIONS ARE IN MILLIMETERS.
2. INTERPRET DIMENSIONS AND TOLERANCES PER ASME Y14.5M, 1994.
3. DIMENSION E1 DOES NOT INCLUDE INTERLEAD FLASH OR PROTRUSION. INTERLEAD FLASH OR PROTRUSION SHALL NOT EXCEED 0.23 PER SIDE.
4. DIMENSIONS b AND b2 DO NOT INCLUDE DAMBAR PROTRUSION. ALLOWABLE DAMBAR PROTRUSION SHALL BE 0.08 TOTAL IN EXCESS OF THE b AND b2 DIMENSIONS AT MAXIMUM MATERIAL CONDITION.
5. TERMINAL NUMBERS ARE SHOWN FOR REFERENCE ONLY.
6. DIMENSIONS D AND E1 ARE TO BE DETERMINED AT DATUM PLANE H.

DIM	MILLIMETERS	
	MIN	MAX
A	---	1.80
A1	0.02	0.11
b	0.60	0.88
b1	0.60	0.80
b2	2.90	3.10
b3	2.90	3.05
c	0.24	0.35
c1	0.24	0.30
D	6.30	6.70
E	6.70	7.30
E1	3.30	3.70
e	2.30	
e1	4.60	
L	0.25	---
α	0°	10°

SOLDERING FOOTPRINT*

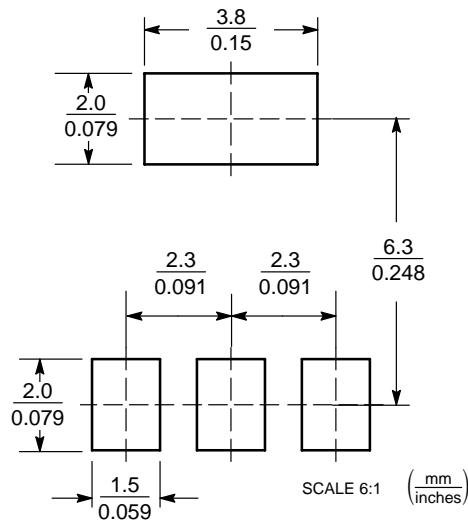

*For additional information on our Pb-Free strategy and soldering details, please download the ON Semiconductor Soldering and Mounting Techniques Reference Manual, SOLDERRM/D.

NCP1117, NCV1117

PACKAGE DIMENSIONS

DPAK
DT SUFFIX
CASE 369C-01
ISSUE O

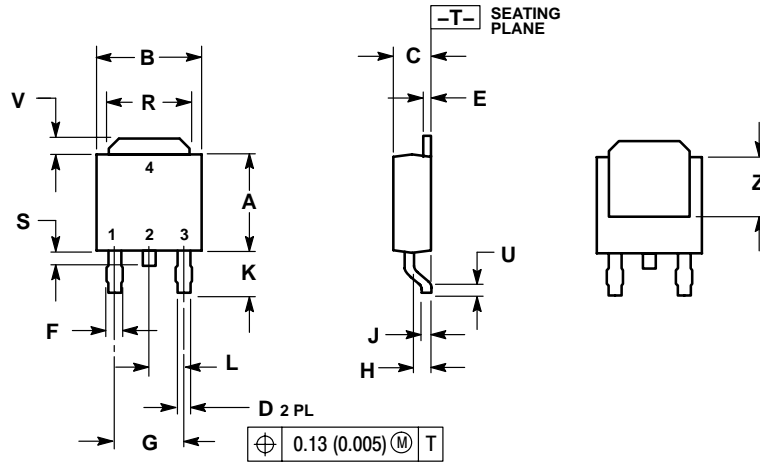

- NOTES:
1. DIMENSIONING AND TOLERANCING PER ANSI Y14.5M, 1982.
2. CONTROLLING DIMENSION: INCH.

DIM	INCHES		MILLIMETERS	
	MIN	MAX	MIN	MAX
A	0.235	0.245	5.97	6.22
B	0.250	0.265	6.35	6.73
C	0.086	0.094	2.19	2.38
D	0.027	0.035	0.69	0.88
E	0.018	0.023	0.46	0.58
F	0.037	0.045	0.94	1.14
G	0.180	BSC	4.58	BSC
H	0.034	0.040	0.87	1.01
J	0.018	0.023	0.46	0.58
K	0.102	0.114	2.60	2.89
L	0.090	BSC	2.29	BSC
R	0.180	0.215	4.57	5.45
S	0.025	0.040	0.63	1.01
U	0.020	---	0.51	---
V	0.035	0.050	0.89	1.27
Z	0.155	---	3.93	---

SOLDERING FOOTPRINT*

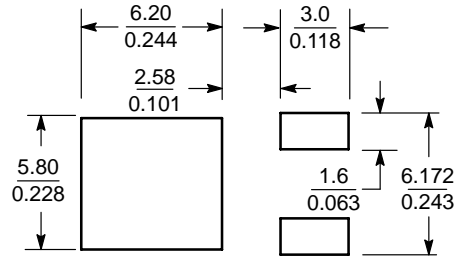

SCALE 3:1 $\left(\frac{\text{mm}}{\text{inches}}\right)$

*For additional information on our Pb-Free strategy and soldering details, please download the ON Semiconductor Soldering and Mounting Techniques Reference Manual, SOLDERRM/D.

NCP1117, NCV1117

ON Semiconductor and  are registered trademarks of Semiconductor Components Industries, LLC (SCILLC). SCILLC reserves the right to make changes without further notice to any products herein. SCILLC makes no warranty, representation or guarantee regarding the suitability of its products for any particular purpose, nor does SCILLC assume any liability arising out of the application or use of any product or circuit, and specifically disclaims any and all liability, including without limitation special, consequential or incidental damages. "Typical" parameters which may be provided in SCILLC data sheets and/or specifications can and do vary in different applications and actual performance may vary over time. All operating parameters, including "Typicals" must be validated for each customer application by customer's technical experts. SCILLC does not convey any license under its patent rights nor the rights of others. SCILLC products are not designed, intended, or authorized for use as components in systems intended for surgical implant into the body, or other applications intended to support or sustain life, or for any other application in which the failure of the SCILLC product could create a situation where personal injury or death may occur. Should Buyer purchase or use SCILLC products for any such unintended or unauthorized application, Buyer shall indemnify and hold SCILLC and its officers, employees, subsidiaries, affiliates, and distributors harmless against all claims, costs, damages, and expenses, and reasonable attorney fees arising out of, directly or indirectly, any claim of personal injury or death associated with such unintended or unauthorized use, even if such claim alleges that SCILLC was negligent regarding the design or manufacture of the part. SCILLC is an Equal Opportunity/Affirmative Action Employer. This literature is subject to all applicable copyright laws and is not for resale in any manner.

PUBLICATION ORDERING INFORMATION

LITERATURE FULFILLMENT:

Literature Distribution Center for ON Semiconductor
P.O. Box 61312, Phoenix, Arizona 85082-1312 USA
Phone: 480-829-7710 or 800-344-3860 Toll Free USA/Canada
Fax: 480-829-7709 or 800-344-3867 Toll Free USA/Canada
Email: orderlit@onsemi.com

N. American Technical Support: 800-282-9855 Toll Free
USA/Canada

Japan: ON Semiconductor, Japan Customer Focus Center
2-9-1 Kamimeguro, Meguro-ku, Tokyo, Japan 153-0051
Phone: 81-3-5773-3850

ON Semiconductor Website: <http://onsemi.com>

Order Literature: <http://www.onsemi.com/litorder>

For additional information, please contact your
local Sales Representative.